

T7351 Commercial Programmable Thermostat

FOR SINGLE- OR MULTI-STAGE CONVENTIONAL/HEAT PUMP SYSTEMS

INSTALLATION INSTRUCTIONS

APPLICATION

The T7351 Commercial Programmable Thermostat controls 24 Vac commercial single zone heating, ventilating and air conditioning (HVAC) equipment. The T7351 consists of a thermostat and subbase. The thermostat includes the display and keypad for 7-day programming. The subbase includes equipment control connections. The subbase mounts on the wall and the thermostat mounts to the subbase.



MERCURY NOTICE

If this control is replacing a control that contains mercury in a sealed tube, do not place your old control in the trash. Dispose of properly.

Contact your local waste management authority for instructions regarding recycling and the proper disposal of an old control. If you have questions, call Honeywell Customer Care Center at 1-800-468-1502.

INSTALLATION

When Installing this Product...

1. Read these instructions carefully. Failure to follow them could damage the product or cause a hazardous condition.
2. Check ratings given in instructions and on the product to ensure the product is suitable for your application.
3. Installer must be a trained, experienced service technician.
4. After installation is complete, check out product operation as provided in these instructions.



CAUTION

Electrical Shock or Equipment Damage Hazard. Can shock individuals or short equipment circuitry.

Disconnect power supply before installation.

Location

Do not install the thermostat where it can be affected by:

- drafts, or dead spots behind doors and in corners.
- hot or cold air from ducts.
- radiant heat from sun or appliances.
- concealed pipes and chimneys.
- unheated (uncooled) areas such as an outside wall behind the thermostat.

IMPORTANT

To avoid electrical interference, which can cause erratic performances, keep wiring runs as short as possible and do not run thermostat wires adjacent to the line voltage electrical distribution systems. Use shielded cable. The cable shield must be grounded only at the controlled equipment case.

Subbase

WHEN USED TO SENSE ROOM TEMPERATURE

Install the thermostat about 5 ft. (1.5m) above the floor in an area with good air circulation at average temperature. (See Fig. 1.)

WHEN NOT USED TO SENSE ROOM TEMPERATURE

When using the remote-mounted temperature (and humidity) sensor(s) to sense ambient conditions, install the thermostat in an area that is accessible for setting and adjusting the temperature and settings.

Install the remote-mounted sensor(s) about 5 ft. (1.5m) above the floor in an area with good air circulation at average temperature (See Fig. 1).

If multiple remote sensors are required, they must be arranged in a temperature averaging network consisting of four sensors (See Fig. 2).

NOTE: Only T7770 models with no setpoint adjustment can be used for temperature averaging.



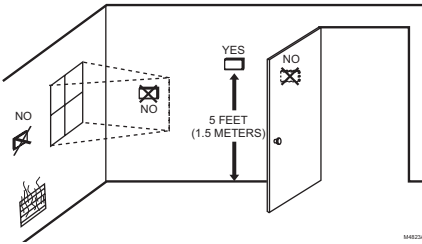

Fig. 1. Typical location of thermostat or remote-mounted sensor.

Mounting Subbase

The subbase mounts horizontally.

IMPORTANT

- When using the internal temperature or humidity sensor, the device must be mounted horizontally (with the LCD facing upwards). Precise leveling is not needed.
- When using remote room temperature and humidity sensors, thermostat mounting orientation does not matter.

Wall mounting (using standard drywall screws) is standard. Mounting to a 2 in. by 4 in. (50.8 mm by 101.6 mm) wiring box can be accomplished:

- for a horizontal box, no extra hardware is required.
- for a vertical box, part 209651A is required.
- Mount to European standard wall box (having 2.4 in. (60.3 mm) between mounting screws in a horizontal line) with or without adaptive hardware.

1. Position and level the subbase.

NOTE: A level wallplate is only for appearance. The thermostat functions properly when not level.

2. Use a pencil to mark the mounting holes. (See Fig. 3).
3. Remove the subbase from the wall and drill two 3/16 in. (4.8 mm) holes in the wall (if drywall) as marked. For firmer material such as plaster or wood, drill two 7/32 in. (5.6 mm) holes.
4. Gently tap anchors (provided) into the drilled holes until flush with the wall.
5. Position the subbase over the holes, pulling wires through the wiring opening.
6. Loosely insert the mounting screws into the holes.
7. Tighten mounting screws.

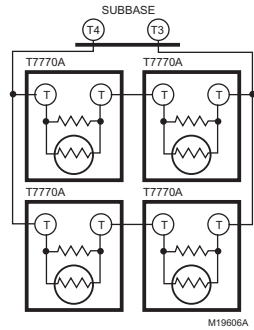

Fig. 2. Four T7770A Sensors providing temperature averaging network for T7351 Thermostat.

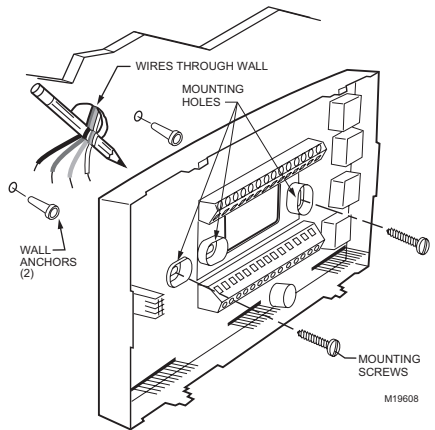

Fig. 3. Mounting the subbase.

Mounting Thermostat on Subbase (Fig. 4)

With the subbase installed, mount the thermostat:

1. Engage top subbase tabs into the thermostat top.
2. Swing the thermostat down.
3. Press the lower edge of the case to latch.

NOTE: To remove the thermostat from the wall, first pull out at the bottom of the thermostat; then remove the top.

A. ENGAGE TABS AT TOP OF THERMOSTAT AND SUBBASE OR WALLPLATE.

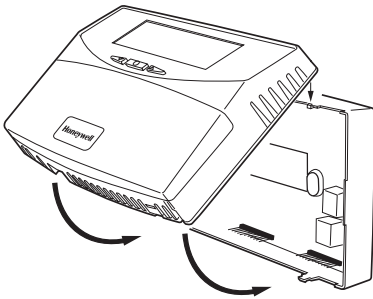

B. PRESS LOWER EDGE OF CASE TO LATCH.

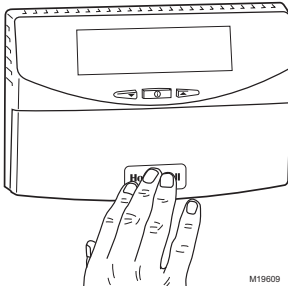

Fig. 4. Mounting thermostat on subbase.

SETTINGS

Using Thermostat Keys

The thermostat keys are used to:

- set current time and day,
- program times and setpoints for heating and cooling,
- override the program temperatures,
- display present setting,
- set system and fan operation.

NOTE: See Fig. 5 for keypad information.

Setting Temperature

Refer to Table 2 for the default temperature setpoints. To set the Occupied and Not Occupied Heat and Cool setpoints, simply press the Heat and Cool button under the Occupied or Not Occupied area of the keypad. To set the Standby Heat setpoint, press both the Occupied and Not Occupied Heat buttons simultaneously. To set the Standby Cool setpoint, press the Occupied Cool and Not Occupied Heat buttons simultaneously.

Setting System and Fan

System default setting is Auto. Fan default setting is On.

NOTE: Use *System* and *Fan* keys to change settings.

System Settings

- Auto: Thermostat automatically changes between heating and cooling based on indoor temperature.
- Cool: Thermostat controls cooling.
- Off: Heating, cooling, and fan are all off.
- Heat: Thermostat controls heating.
- Em Heat: Auxiliary heat serves as first stage. Compressor stages are locked off.

Fan Settings

- On: See Table 1.
- Auto: Fan always cycles with call for heat or cool.
 - Conventional: The equipment (i.e. plenum switch) controls fan operation in heat mode. Thermostat controls fan operation in cool mode.
 - Electric Heat: Thermostat controls fan operation in both heat and cool modes.

NOTES: Fan operation can extend (delay Off) after the heating/cooling turns off:

- Heating choices are 0 or 90 seconds.
- Cooling choices are 0 or 40 seconds.

Table 1. Fan On Control Logic.

Occupancy		Call for Heat/Cool	
Scheduled	Sensor Signal	Yes	No
Occupied	Occupied	On	On
Occupied	Standby	On	Off ^a
Standby	—	On	On
Not Occupied	—	On	Off ^a

^a In heat mode, when set for conventional heat, the equipment (i.e. plenum switch) could power the fan despite the T7351.

Wiring

Follow equipment manufacturer wiring instructions when available. Refer to the Wiring Diagram section for typical hookups. A letter code is located near each terminal for identification.

IMPORTANT

All wiring must comply with local electrical codes and ordinances.

NOTE: Maximum (and recommended) wire size is 18-gauge. Do not use wire smaller than 22-gauge.

1. Loosen subbase terminal screws and connect system wires.
2. Securely tighten each terminal screw.
3. Push excess wire back into the hole in the wall.
4. Plug the hole with nonflammable insulation to prevent drafts from affecting the thermostat.

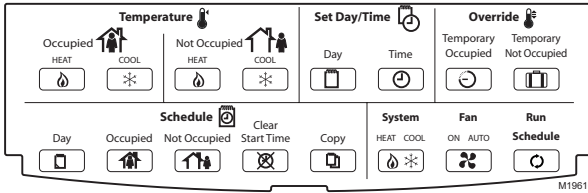

Fig. 5. Thermostat key locations.

INSTALLER SETUP

For most applications, the thermostat factory settings do not need to be changed. Review the factory settings in Table 2.

NOTE: When power is first applied to the thermostat, the display will show all segments (see Fig. 6).

Table 2. Default Setpoints.

Control	Occupied	Not Occupied	Standby
Heating	70° F (21° C)	55° F (13° C)	67° F (19° C)
Cooling	75° F (24° C)	85° F (29° C)	78° F (26° C)

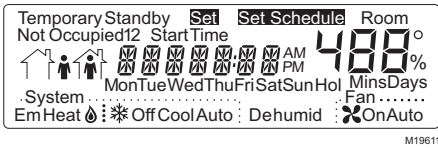

Fig. 6. LCD display of all segments.

CAUTION

Possible Equipment Damage.
Fan must be running when system is operating.

Heat pump and electric heat systems must be configured correctly to prevent equipment damage caused by the system running without the fan.

Setup Using Keypad

The installer uses the Installer Setup to customize the thermostat to specific systems

A combination of key presses are required to use the Installer Setup feature:

1. To enter the Installer Setup, press and hold both the *Run Schedule* and the *Copy* keys until DEGREES 00 (or DEGREES 01) displays.

NOTE: Installer Setup will display WAIT and is unavailable for 30 seconds after power up.

2. To advance to the next Installer Setup number, press **1**.

NOTE: Pressing *Run/Copy* again while in this mode displays the T7351 firmware version number.

3. To return to a Setup item, cycle through the options.
4. To change a setting, use the up ▲ or down ▼ key.
5. To exit the Installer Setup, press *Run Schedule*.
6. Display prompts SAV CFG (save configuration).
 - a. If you want to save the new configuration, use the up ▲ or down ▼ key to change NO to YES before pressing *Run Schedule*.
 - b. If you want the configuration to remain as it was before starting this change, ensure the display indicates SAV CFG NO and press *Run Schedule*.

NOTE: Installer Setup is automatically exited after five minutes with no key pressed. Upon this automatic exit, all changes are lost.

Configuration

Configuration can be done with the keypad using the Installer Setup (ISU).

Table 3. Installer Setup.

Text	Default	Choices	Notes
DEGREES	0	0 - 1	Degree Temperature Format 0: Degrees F 1: Degrees C
CLOCK	0	0 - 1	Clock Display Format 0: 12 hour 1: 24 hour
KEYLOCK	0	0 - 3	Keypad Lockout Level 0: None 1: Lockout all keys except Set Day, Set Time, Set Date, Set Holidays, Temporary Occupied, Temporary Not Occupied, System, Fan, Up, Down and Information 2: Lockout all keys except Set Day, Set Time, Set Date, Set Holidays, Temporary Occupied, Temporary Not Occupied, Up, Down and Information 3: Lockout all keys except Information
HEATPMP	0	0 - 2	Application Type Selection 0: Conventional 1: Heat Pump - Cooling (Energize O/B on call for cool) 2: Heat Pump - Heating (Energize O/B on call for heat)
COOLSTG	1	0 - 4	Number of Cooling Stages 0: 0 Stages of Cooling 1: 1 Stages of Cooling 2: 2 Stages of Cooling 3: 3 Stages of Cooling 4: 4 Stages of Cooling (W3 will be used as 4th stage relay)
HEATSTG	1	0 - 3	Number of Heating Stages 0: 0 Stages of Heating 1: 1 Stages of Heating 2: 2 Stages of Heating (This is the max if 4 cooling stages is selected) 3: 3 Stages of Heating
AUX STG	0	0 - 2	Only shown when Heat Pump is selected 0: 0 Aux Stages 1: 1 Aux Stages 2: 2 Aux Stages
AUX CON	0	0 - 3	Aux Contact Functionality 0: Time of Day 1: Economizer 2: Dehumid - Hot Gas Bypass 3: Simple Dehumid
WALLMOD	0	0 - 3	Remote Room Sensor Selection 0: Local sensor only 1: T7770A/D (Remote Sensor, No Remote Setpoint, Bypass 0) 2: T7770B/C (Remote Sensor, Remote Setpoint, Bypass 0) 3: T7771 (Remote sensor, Remote Setpoint, Bypass 1) (Display only if sub-base 2, 3, 4+) (This item is not displayed when
OATSENS	0	0 - 1	Outdoor Air Sensor Selection 0: None 1: Remote Outdoor Air Sensor
DATSENS	0	0 - 1	Discharge Air Sensor Selection 0: None 1: Remote Discharge Air Sensor
HUMSENS	0	0 - 2	Room Humidity Sensor selection 0: None 1: On Board Sensor 2: Remote Sensor
OCCSENS	0	0 - 1	Occupancy Sensor Selection 0: None 1: Remote Occ Sensor
FAN HT	0	0 - 1	Fan Operation on Heat 0: Conventional (Equipment controls Fan) 1: Electric (Thermostat turns on Fan with call for Heat)

Table 3. Installer Setup. (Continued)

Text	Default	Choices	Notes
XFAN HT	YES	YES or NO	Extended Fan on Heat NO: None YES: 90 seconds
XFAN CL	NO	YES or NO	Extended Fan on Cool NO: None YES: 40 seconds
STRTDEL	0	0 - 15	Sequential Start Delay 0 to 150 seconds in 10 second increments
ADVANCE	NO	YES or NO	Advanced Settings NO: Hide YES: Show
TMP LIM	3	0 - 5	Temporary Setpoint Adjustment 0: 0 Deg. F 1: 1 Deg. F 2: 2 Deg. F 3: 3 Deg. F 4: 4 Deg. F 5: 5 Deg. F
TMP OCC	3	1 - 8	Temporary Occupied Duration 1 to 8 hours
TMP CAL	0	-4 - 3	Temporary Display Adjustment 0 - 3 = 0 to 3 DDF 4 - 7 = -4 to -1 DDF
MINCOOL	45° F (7° C)	45° - 99° F (7° - 37° C)	Min Cool Setpoint
MAXHEAT	90° F (32° C)	40° - 90° F (4° - 32°)	Max Heat Setpoint
HEATLCK	NO	YES or NO	Heating Lockout (Only displayed if Outdoor Air Sensor is selected) NO: None YES: Enabled
HTLCKSP	70° F (21° C)	-40° - 120° F (-40° - 49° F)	Heating Lockout Temperature (Display only if Remote Outdoor Air Sensor is configured)
COOLLCK	NO	YES or NO	Cooling Lockout (Only displayed if Outdoor Air Sensor is Selected) NO: None YES: Enabled
CLLCKSP	35° F (2° C)	-40° - 120° F (-40° - 49° C)	Cooling Lockout Temperature (Display only if Remote Outdoor Air Sensor is configured)
DAT LL	NO	YES or NO	Discharge Low Limit (Only displayed if Discharge Air Sensor is Selected) NO: None YES: Enabled
DATLLSP	45° F (7° C)	35° - 60° F (2° - 16° C)	Discharge Low Temp Limit (Display only if Discharge Sensor is configured)
DAT HL	NO	YES or NO	Discharge High Limit (Only displayed if Discharge Air Sensor is Selected) NO: None YES: Enabled
DATHLSP	110° F (43° C)	65° - 140° F (18° - 60° C)	Discharge High Temperature Limit (Display only if Discharge Sensor is configured)
DEHUMID	0	0 - 5	Dehumidification 0: None 1: MinOn Time 2: Reset Temp Setpoint 3: Reset w/ MinOn 4: Reheat 5: Reheat w/ Min On
DEH MIN	5	5 - 15	Dehumidify Minutes On
DEH TMP	2	1 - 5	Dehumidify Temp Reset
MINHTRT	5	0 - 20 DDF/HR	Minimum Heat Recovery Ramp Rate
MAXHTRT	8	0 - 20 DDF/HR	Maximum Heat Recovery Ramp Rate (Only Displayed if Outdoor Sensor is Selected)
MINHTOA	0° F (-18° C)	-20° - 120° F (-29° - 49° C)	Minimum Heat Outdoor Air Temperature (Only Displayed if Outdoor Sensor is Selected)

Table 3. Installer Setup. (Continued)

Text	Default	Choices	Notes
MAXHTOA	40° F (4° C)	-20° - 120° F (-29° - 49° C)	Maximum Heat Outdoor Air Temperature (Only Displayed if Outdoor Sensor is Selected)
MINCLRT	3	0 - 20 DDF/HR	Minimum Cool Recovery Ramp Rate
MAXCLRT	6	0 - 20 DDF/HR	Maximum Cool Recovery Ramp Rate (Only Displayed if Outdoor Sensor is Selected)
MINCLOA	90° F (32° C)	-20° - 120° F (-29° - 49° C)	Minimum Cool Outdoor Air Temperature (Only Displayed if Outdoor Sensor is Selected)
MAXCLOA	70° F (21° C)	-20° - 120° F (-29° - 49° C)	Maximum Cool Outdoor Air Temperature (Only Displayed if Outdoor Sensor is Selected)
			(DayLight Savings options only display when Date is valid)
DSTMON1	3	0 - 12	DLS Spring Month
DSTDAY1	40	0 - 31, 32 - 74	DLS Spring Day 0 - 31 = Day of Month 32 = Last Day of Month 33 = First Sunday etc...
DSTMON2	11	0 - 12	DLS Fall Month
DSTDAY2	33	0 - 31, 32 - 74	DLS Fall Day 0 - 31 = Day of Month 32 = Last Day of Month 33 = First Sunday etc...
HT RESP	1	0 - 3	0: Standard - 3 cph 1: Medium - 6 cph 2: Fast - 9 cph 3: Super Fast - 20 cph
CL RESP	0	0 - 1	0: Standard - 3 cph 1: Fast - 4 cph

Holidays and 365 - Day Clock

The T7351 can be configured to schedule up to 10 separate holidays, each with a duration of up to 99 days. To enable this function, the user must set the date:

1. Press Set Day and Set Time keys simultaneously.
2. Use the Up/Down keys to set the date to YES, then press the **1** key.
3. Use the Up/Down keys to set the month, then press the **1** key.
4. Use the Up/Down keys to set the day, then press the **1** key (See Table 4 for valid day choices).
5. Use the Up/Down keys to set the year, then press the **1** key.























Holidays can be set in the following manner:

1. Press the "Temporary Occupied" and Temporary Not Occupied" keys simultaneously.
 2. The month (MON) of the first holiday is then displayed (00 means the holiday is ignored).
 3. Use the Up/Down keys to set the month, then press the **1** key.
 4. Use the Up/Down keys to set the day, then press the **1** key (see Table 4 for valid day choices).
 5. Use the Up/Down keys to set the duration.
- The first holiday is now set and pressing the **1** key will take you to programming the second holiday (denoted by the number 2 on the screen).

Table 4. Valid Day Values.

Value	Description	Value	Description	Value	Description	Value	Description
1 to 31	Day of month	42	Second Tuesday	53	Third Saturday	64	Fifth Wednesday
32	Last Day of Month	43	Second Wednesday	54	Fourth Sunday	65	Fifth Thursday
33	First Sunday	44	Second Thursday	55	Fourth Monday	66	Fifth Friday
34	First Monday	45	Second Friday	56	Fourth Tuesday	67	Fifth Saturday
35	First Tuesday	46	Second Saturday	57	Fourth Wednesday	68	Last Sunday
36	First Wednesday	47	Third Sunday	58	Fourth Thursday	69	Last Monday
37	First Thursday	48	Third Monday	59	Fourth Friday	70	Last Tuesday
38	First Friday	49	Third Tuesday	60	Fourth Saturday	71	Last Wednesday
39	First Saturday	50	Third Wednesday	61	Fifth Sunday	72	Last Thursday
40	Second Sunday	51	Third Thursday	62	Fifth Monday	73	Last Friday
41	Second Monday	52	Third Friday	63	Fifth Tuesday	74	Last Saturday

Table 5. T7351 Key Function Summary.

Grouping	Button	Definition
Information	Down Arrow 	Lowers setpoint, day, or time. When setting times or temperatures, hold key down to continuously decrease value. Also can make temporary change in temperature setpoint.
	Information 	Obtains information (where humidity "high-limit" can be set), cycles through setup options.
	Up Arrow 	Raises setpoint, day, or time. When setting times or temperatures, hold key down to continuously increase value. Also can make temporary change in temperature setpoint.
Temperature 	Occupied Heat 	Sets Occupied Heat setpoint.
	Occupied Cool 	Sets Occupied Cool setpoint.
	Not Occupied Heat 	Sets Not Occupied Heat setpoint.
	Not Occupied Cool 	Sets Not Occupied Cool setpoint.
Set 	Day 	Sets day of week. Tapping key with 'Set Value' segment on increases current day (same effect as <i>Up Arrow</i> key).
	Time 	Sets time. Tapping key with "Set Value" segment on increases time in one hour increments.
Override 	Temporary Occupied 	Temporary occupied setting for length of time defined by installer. User can modify setpoints.
	Temporary Not Occupied 	Sets holiday length. User selects number of days ("0"- "99"), or "----" for continuous override.
Schedule 	Day 	Selects day schedule to modify. (Used also with copy key.)
	Occupied 	Selects occupied event start times for specified day. Repeatedly press this key to toggle between two occupied events.
	Not Occupied 	Selects not occupied event start times for specified day. Repeatedly press this key to toggle between two not occupied events.
	Clear Start Time 	Clears start time for specified period and day.
	Copy 	Copies schedule from one day to another.
	System 	Selects System Mode. Toggles through Em Heat, Heat, Off, Cool, and Auto.
	Fan 	Selects fan operation mode. Toggles between On and Auto. ^a
Run Schedule 	Resumes running schedule (cancels Temporary Occupied action, Holiday, and/or Temporary setpoint changes.)	

^a On: Continuous fan operation (occupied and standby). During not occupied periods, fan cycles with call for heat or cool.
Auto: Fan cycles with call for heat or cool during all periods. (See Product Data Sheet, form 63-2605, for more details).

NOTES: The display returns to default screen after pressing Run Schedule (or after a period of time without keypress):

- ten seconds: when returning from temporary setpoint changes, info screen, temp occ, and temp not occ.
- one minute: when returning from setting clock/day.
- ten minutes: when returning from System Checkout.
- five minutes: when returning from all other modes.

Special Functions

Restore Factory Configuration (Run/Clear)

IMPORTANT

This operation erases current configuration and restores factory defaults for all configuration, parameters, setpoints and schedules. To regain the old requires device reconfiguration.

1. Press both *Run Schedule* and *Clear Start Time*.
2. The display gives the option to revert to FAC CFG.
 - a. To restore the factory defaults, press up ▲ or down ▼ until the display indicates YES.
 - b. To cancel this option, ensure the display indicates NO.
3. Press *Run Schedule*.

Get Factory Schedule (Info/Clear)

Performing this operation reverts the schedules to the factory defaults:

1. Press both *Info* and *Clear Start Time*.
2. The display gives the option to revert to FAC SCH.
 - a. To restore the factory schedule, press up ▲ or down ▼ until the display indicates YES.
 - b. To cancel this option, ensure display indicates NO.
3. Press *Run Schedule*.

Test Mode (Occupied/Not Occupied/Schedule Day)



CAUTION

Possible Equipment Damage.
Equipment damage can result if compressor is cycled too quickly.

The minimum off time for compressors is bypassed during Test Mode. Equipment damage can occur if the compressor is cycled too quickly.

Use the Test Mode to check the thermostat configurations and operation. To start the system test:

1. Press *Schedule Day*, *Occupied* and *Not Occupied* simultaneously.
2. The display gives the option to TEST.
 - a. To enter test mode, press up ▲ or down ▼ until the display indicates IN TEST.
 - b. To cancel this option, ensure display indicates NO TEST.
3. Press *Run Schedule*.

NOTES:

- To verify whether or not the system test is still active, repeat the above process.
- The system test times out after ten minutes with no key pressed.

Save User Schedule (Info/Copy)

Performing this operation saves the current schedule (including holidays) to memory, overwriting the old saved schedule:

1. Press both *Info* and *Copy*.
2. The display gives the option to revert to SAV SHD.
 - a. To save the current schedule, press up ▲ or down ▼ until the display indicates YES.
 - b. To cancel this option, ensure display indicates NO.
3. Press *Run Schedule*.

Get User Schedule (Info/Run)

Getting the user schedule restores the schedule (including holidays) from saved memory, overwriting the schedule currently in use:

1. Press both *Run Schedule* and *Info*.
2. The display gives the option to GET SHD.
 - a. To retrieve the saved schedule, press up ▲ or down ▼ until the display indicates YES.
 - b. To cancel this option, ensure display indicates NO.
3. Press *Run Schedule*.

DEHUMIDIFICATION

There are five methods through which the T7351 can control for dehumidification. Three of them modify the control algorithm, thus providing limited dehumidification through cooling. The other two use the auxiliary output to control another device.

NOTE: The dehumidification high limit can be set within the range of 10 to 90 percent relative humidity.

Control Through Cooling

Configure using some combination of the following:

- Minimum On.
- Reheat.
- Reset.

NOTES:

- These methods operate only during cooling.
- Selecting both Reheat and Reset options can cause frequent setpoint adjustments. This selection is not recommended.

Min. ON Time

Dehumidifies by increasing the compressor minimum on time (normally 3 minutes) by a programmable amount. This is useful with oversized systems in that it forces the coils to cool to a point where dehumidification can occur.

NOTES:

- Can force wider temperature swings by cooling when setpoint control does not require it.
- The minimum on time can be set within the range of 5 to 15 minutes.
- Hysteresis and a minimum timer are used to ensure this behavior does not change with every equipment cycle.

Reheat

Dehumidifies by operating cooling during typical off time. The T7351 maintains the proper setpoint by running the heat at the same time.

IMPORTANT

At times during Reheat dehumidification, the T7351 operates heating and the cooling simultaneously. This is normal.

NOTES:

- The heat stage never energizes during Reheat if more than one cool stage is on.
- Reheat mode cannot occur during heating.

Reset Temp SetPt

The room temperature set point resets to a specified number of degrees below the actual set point when room relative humidity (RH) rises above humidity high limit set point.

Though this may not technically reduce relative humidity in the room, it reduces the dew point to provide the customer with a sense of comfort due to a lower temperature setting in the room.

As long as RH stays above humidity high limit set point, this set point is maintained.

NOTE: Hysteresis and a minimum timer prevent the set point from short interval alternation (between standard and reset set points).

Options Utilizing Auxiliary Output

There are two dehumidification options that utilize the auxiliary output. They are:
 — Simple Dehumidification.
 — Hot Gas Bypass Dehumidification.

Simple Dehumid(ification)

The auxiliary output:
 — Energizes when RH rises above humidity high limit.
 — De-energizes when RH drops below humidity high limit.

NOTES:

- Hysteresis and a minimum timer prevent short cycling of this output.
- Unlike Dehumid Hot Gas BP the relay remains energized during calls for multiple cooling stages.

Dehumid Hot Gas BP

The auxiliary output operates as shown in Table 6.

Table 6. Hot Gas Bypass Dehumidification Logic.

Humidity	Cooling Stages Active	Auxiliary Output
High	more than one	De-energized
High	one or less	Energized
Low	more than one	De-energized
Low	one or less	De-energized

Auxiliary output during call for multiple cooling stages for two reasons:

1. This method assumes that the cooling provides dehumidification.
2. Multiple cooling stages probably provide necessary dehumidification.
3. Hysteresis and a minimum timer prevent short cycling of this output.

WIRING DIAGRAMS

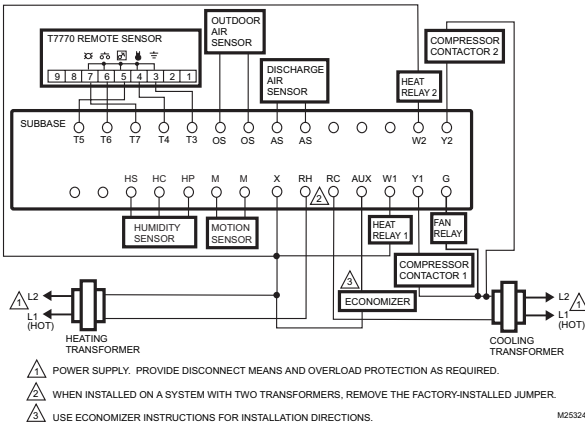

Fig. 7. Typical hookup of T7351F2010 in two-stage heat and two-stage cool heat pump system with two transformers.

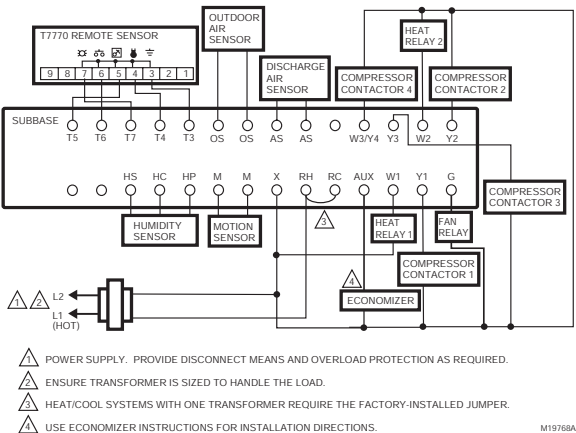

Fig. 8. Typical hookup of T7351F2010U in two-stage heat and four-stage cool conventional system.

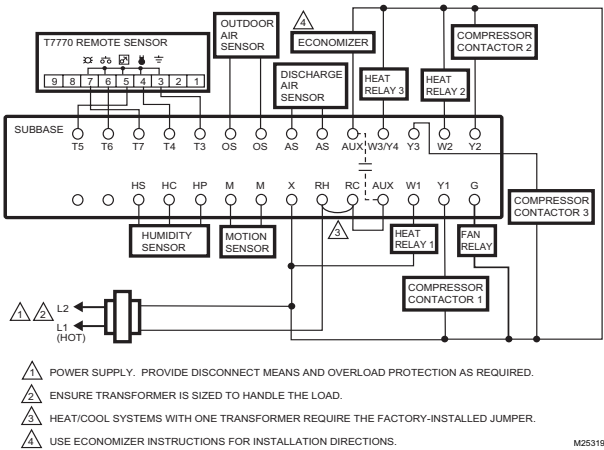

Fig. 9. Typical hookup of T7350F2010 in three-stage heat and three-stage cool conventional system with one transformer.

TROUBLESHOOTING GUIDE (TABLE 7)

Table 7. Troubleshooting Information.

Symptom	Possible Cause	Action
Display will not come on.	Thermostat is not being powered.	Check that X terminal is connected to the system transformer. Check for 24 Vac between X and RH terminals. If missing 24 Vac: <ul style="list-style-type: none"> • Check if circuit breaker is tripped; if so, reset circuit breaker. • Check if system fuse is blown; if so, replace fuse. • Check if the HVAC equipment power switch is in the Off position; if so, set to the On position. • Check wiring between thermostat and HVAC equipment. Replace broken wires and tighten loose connections. If 24 Vac is present, proceed with troubleshooting.
Temperature display is incorrect.	Thermostat is configured for °F or °C display.	Press both <i>Run Schedule</i> and <i>Copy</i> , then reconfigure the display.
	Bad thermostat location.	Relocate the thermostat.
	Display shows three dashes and a degree sign (all systems shut down).	T7351 is set for remote sensing and sensor is missing or circuit is either open or shorted.
Temperature settings will not change. (Example: Cannot set heating higher or cooling lower.)	Upper or lower temperature limits were reached.	Check the temperature setpoints: <ul style="list-style-type: none"> • Heating limits are 40 to 90°F (7 to 31°C) • Cooling limits are 45 to 99°F (9 to 37°C)
	Occupied setpoint temperature range stops were configured.	Check setpoint stops. If necessary, reconfigure the stop(s).
	Keypad is locked. When a locked key is pressed, LOCKED appears momentarily on the LCD.	Press both <i>Run Schedule</i> and <i>Copy</i> , then change keypad lock level.
Room temperature is out of control.	Remote temperature sensing is not working.	Check all remote sensors.

Table 7. Troubleshooting Information. (Continued)

Symptom	Possible Cause	Action
Heat will not come on.	No power to the thermostat.	Check that X terminal is connected to the system transformer. Check for 24 Vac between X and RH terminals. If missing 24 Vac: <ul style="list-style-type: none"> • Check if circuit breaker is tripped; if so, reset circuit breaker. • Check if system fuse is blown; if so, replace fuse. • Check if the HVAC equipment power switch is in the Off position; if so, set to the On position. • Check wiring between thermostat and HVAC equipment. Replace broken wires and tighten loose connections. If 24 Vac is present, proceed with troubleshooting.
	Thermostat minimum off time is activated.	<ul style="list-style-type: none"> • Wait up to five minutes for the system to respond. • Configure heating response.
	System selection is set to Off or Cool.	Set system selection to Heat or Auto.
Cooling will not come on.	No power to the thermostat.	Check that X terminal is connected to the system transformer. Check for 24 Vac between X and RH terminals. If missing 24 Vac: <ul style="list-style-type: none"> • Check if circuit breaker is tripped; if so, reset circuit breaker. • Check if system fuse is blown; if so, replace fuse. • Check if the HVAC equipment power switch is in the Off position; if so, set to the On position. • Check wiring between thermostat and HVAC equipment. Replace broken wires and tighten loose connections. If 24 Vac is present, proceed with troubleshooting.
	Thermostat minimum off time is activated.	<ul style="list-style-type: none"> • Wait up to five minutes for the system to respond. • Configure cooling response.
	System selection is set to Off or Heat.	Set system selection to Cool or Auto.
System indicator (flame: heat, snowflake: cool) is displayed, but no warm or cool air is coming from the registers.	The call for heat or cool is not yet given.	Check if any stage indicators (dots next to the system indicator) are displayed. With no display of stage indicators, no call for cool/heat is yet given.
	Conventional heating equipment turns the fan on only after the furnace has warmed to a setpoint.	Wait one minute after seeing the on indicator and then check the registers.
	Heating or cooling equipment is not operating.	Verify operation of heating or cooling equipment in self-test.

Automation and Control Solutions

Honeywell International Inc.
 1985 Douglas Drive North
 Golden Valley, MN 55422
 customer.honeywell.com

Honeywell Limited-Honeywell Limitée
 35 Dynamic Drive
 Toronto, Ontario M1V 4Z9

Honeywell

